

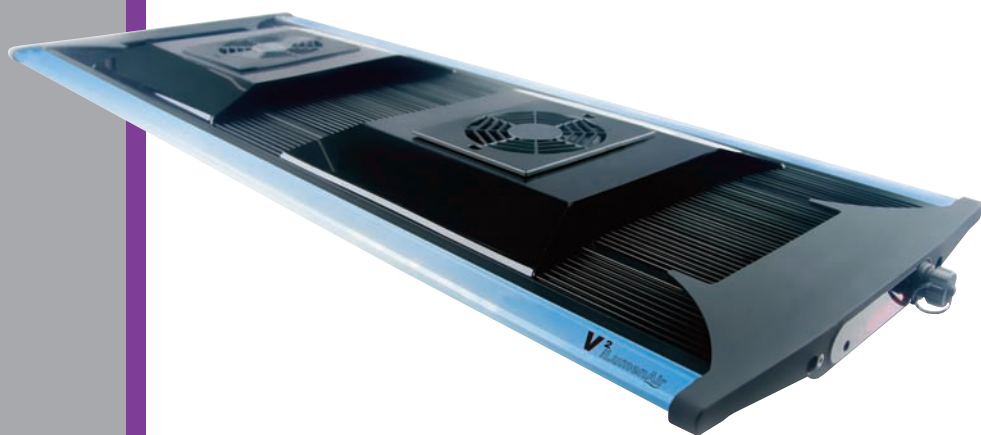



# V<sup>2</sup> *iLumenAir* 900/1200 CE



# V<sup>2</sup>iLumenAir 900/1200

## INSTRUCTIONS FOR INSTALLATION AND USE

### Important Safety Information - Please Read Carefully

- **Caution:** Do not use any other power supply unit with the V<sup>2</sup>iLumenAir as the light unit may not work and this may cause irreparable damage to the light unit. If the PSU supplied with the unit needs to be replaced then please obtain an authentic V<sup>2</sup>iLumenAir PSU supplied by one of Tropical Marine Centre's local stockists. 
- Always isolate the PSU from the mains electricity before installing or carrying out any maintenance.
- **Caution:** Do not operate this appliance if any part of it has a damaged cord or plug, is malfunctioning, or has been dropped, immersed in water or damaged in any way. If the external cord of this unit is damaged, it should be replaced by a cord exclusively available from the manufacturer or his service agent.
- This unit is designed to be used indoors and is not suitable for any outdoor applications. 
- **Caution:** Ensure the light unit is securely installed above the tank before operating.
- **Caution:** Always leave a drip-loop in the DC supply cable to the V<sup>2</sup>iLumenAir light unit to prevent water running down the cable and reaching the PSU (see picture below).
- **Caution:** Do not splash or submerge the lamp or power supply.
- **Caution:** Do not obstruct the cooling fans in any way.
- To prolong the life of your lamp unit please ensure that it is kept free of dust, salt and other debris.
- Dispose of this unit responsibly. Check with your local authority for disposal information. 

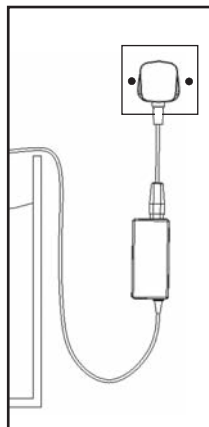

## Product Specification

Model: V<sup>2</sup>iLumenAir 900  
 Size: 690 x 260 x 40mm  
 Suitable for tanks 730 - 1200mm long  
 x 300 - 880mm wide  
 Input: 100-240V 50/60Hz  
 Total Power: 170W  
 Total Luminous Flux: 9000lm

## Product Specification

Model: V<sup>2</sup>iLumenAir 1200  
 Size: 812 x 260 x 40mm  
 Suitable for tanks 840 - 1300mm long  
 x 300 - 880mm wide  
 Input: 100-240V 50/60Hz  
 Total Power: 215W  
 Total Luminous Flux: 10000lm

## Parts List

Please ensure that you have all parts shown below.



### Wire suspension kit (sold separately)

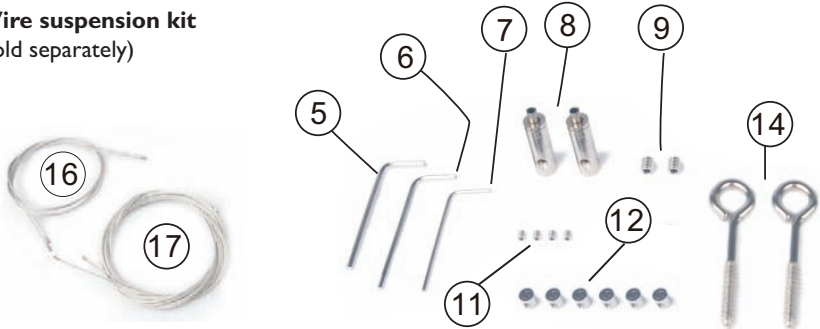

# Installation

The V<sup>2</sup>iLumenAir can be mounted via the tank mounting kit (supplied) or wire suspension kit (V<sup>2</sup>iLumenAir 900 - sold separately).

## a. Tank Mounting - V<sup>2</sup>iLumenAir 900

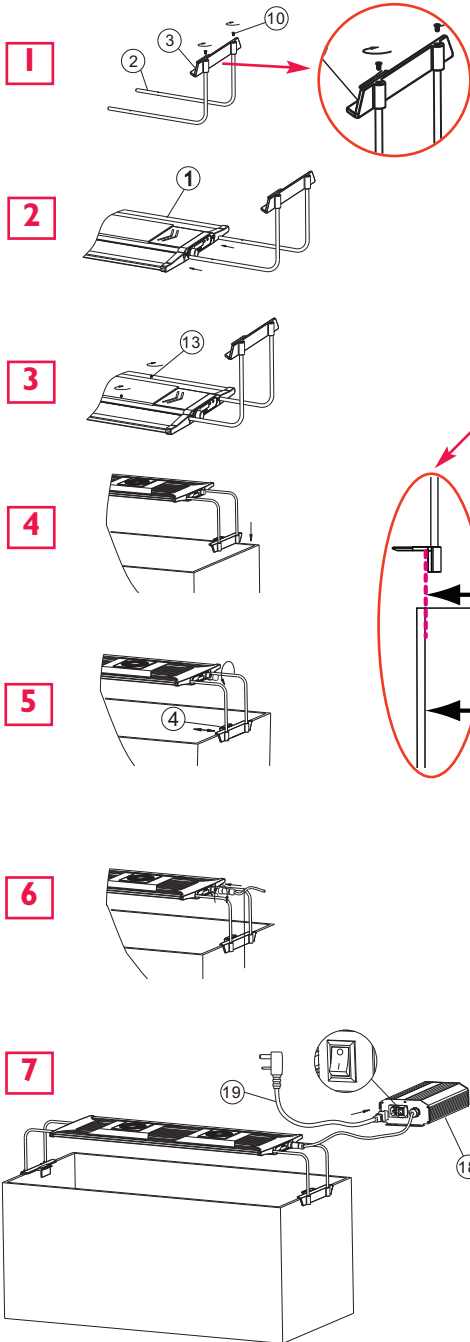

## b. Tank Mounting V<sup>2</sup>iLumenAir 1200

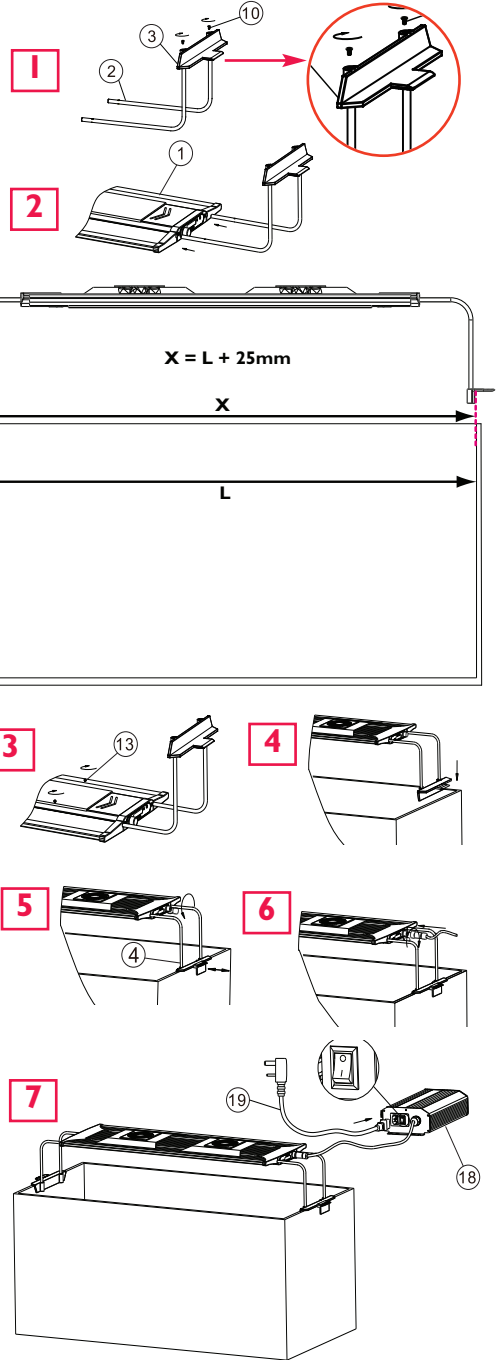



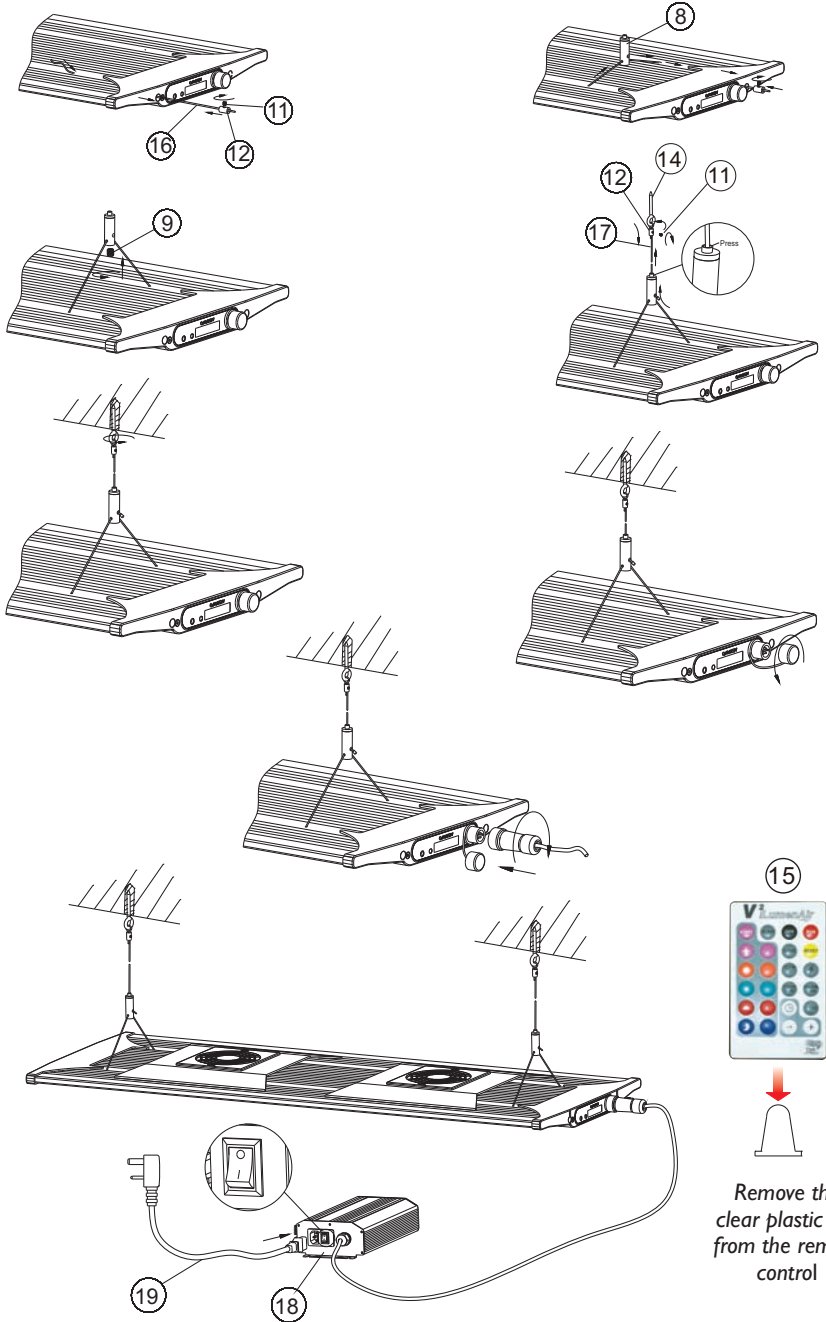

## c. Wire Suspension

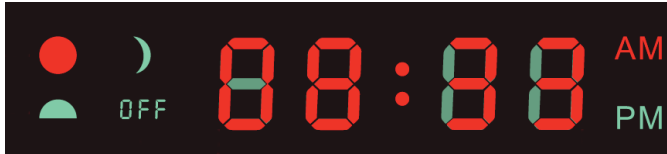

## Display Screen



-  shows when in daytime phase
-  shows when in sunrise or sunset phase
-  shows when in dawn or moonlight phase
-  shows when the light is off

- In run mode the display shows the time in either 24 or 12 hour clock format.
- When setting the phases the first digit represents the time period you are setting:-
  - 1 indicates dawn
  - 2 indicates sunrise
  - 3 indicates daytime
  - 4 indicates sunset
  - 5 indicates moonlight.
- The letter represents which LED channel you are setting:-
  - A is the white channel
  - b is the blue channel
  - C is the colour mix
- The last two digits indicate the brightness level of the channel from '00' to '32'.
- In storm mode the display indicates the frequency of lightning strikes from '1' to '8'.
- In colour demo mode the display indicates the frequency of colour variation from 'Co01' to 'Co12'.
- If the display shows  that means that this fixture is a slave to another control unit.



# Operating Instructions

## Quick start

1. Ensure the clear plastic battery protection tab is removed from the bottom of the remote control (see page 4).

2. To use the remote control, point it at the infrared sensor at the cable entry to the light unit.

3. Press  to set the clock. Press once to adjust the hour and twice to adjust the minute.

Use  and  to adjust up or down.

The time setting will be automatically saved after ten seconds, or you can press  to go back to your user set program with the updated time.

4. Press  to choose between 24 hour and 12 hour clock format.

5. Press  to run the set program (details of the factory set program on page 8).

6. Press  to switch the light off.

7. Press  to enter storm mode. Use  and  to change the frequency of lightning strikes.

Press  to return to the set program.

8. Press  to enter a colour demo. Use  and  to change the speed of the transitions.







































In the slowest settings this can be used to simulate clouds passing over. Press  to return to the set program.

9. Press  repeatedly to cycle the display through, showing the temperature of the light unit in °C and °F and the electrical power being drawn by the light unit in Watts.

10. Press  to slave the unit from another controller (sold separately).



## Programming

1. Press  to set the start time for your photoperiod. Press once to adjust the hour and twice to adjust the minute. Use  and  to adjust up or down.
2. Press  to save your settings.
3. Press  to set the **dawn** phase duration. Press once to adjust the hours and twice to adjust the minutes. Use  and  to adjust up or down.
4. Press  repeatedly to choose between the white, blue and colour mixing channel. Adjust the brightness of each channel using  and  to create your preferred dawn effect.
5. Press  to save your settings.
6. Press  to set the **sunrise** phase duration. Press once to adjust the hours and twice to adjust the minutes. Use  and  to adjust up or down.
7. Press  repeatedly to choose between the white, blue and colour mixing channel. Adjust the brightness of each channel using  and  to create your preferred sunrise effect.
8. Press  to save your settings.
9. Press  to set the **daytime** phase duration. Press once to adjust the hours and twice to adjust the minutes. Use  and  to adjust up or down.
10. Press  repeatedly to choose between the white, blue and colour mixing channel. Adjust the brightness of each channel using  and  to create your preferred daytime effect.
11. Press  to save your settings.
12. Press  to set the **sunset** phase duration. Press once to adjust the hours and twice to adjust the minutes. Use  and  to adjust up or down.
13. Press  repeatedly to choose between the white, blue and colour mixing channel. Adjust the brightness of each channel using  and  to create your preferred sunset effect.
14. Press  to save your settings.
15. Press  to set the **moonlight** phase duration. Press once to adjust the hours and twice to adjust the minutes. Use  and  to adjust up or down.
16. Press  repeatedly to choose between the white, blue and colour mixing channel. Adjust the brightness of each channel using  and  to create your preferred moonlight effect.
17. Press  to save your settings.





Once you have set your program, you can see a demo of your settings by pressing . This will run through the 24 hour photoperiod in just over 2 minutes (1 second = 10 minutes of the cycle).

**NOTE:** If the total number of hours in your photoperiod is less than 24 hours then the light will turn off after the moonlight phase and will come on again at the start time. If the total is more than 24 hours then the part over 24 hours will be overridden by the dawn at the set start time.

## Daylight Recommendations

The suggestions below are for guidance purposes only. Corals can be kept in deeper aquariums. Please note that it is up to you to ensure that your corals receive the correct amount of light. Refer to your local fish store if you are unsure.

### Small Polyp Stony Coral

All channels 100% (32) for 60cm+ deep tanks

All channels 90% (29) for 45cm deep tanks

All channels 75% (24) for 30cm deep tanks

### Large Polyp Stony Coral

All channels 75% (24) for 60cm deep tanks

All channels 65% (20) for 45cm deep tanks

All channels 55% (17) for 30cm deep tanks

### Soft Coral

All channels 65% (20) for 60cm deep tanks

All channels 55% (17) for 45cm deep tanks

All channels 45% (14) for 30cm deep tanks

## Factory Settings

To reset to the factory settings press then

Functions	Buttons	Start Time/ Duration	Set Brightness		
			White	Blue	Colour Mix
Light Start time		05:00 (start time)	-	-	-
Dawn duration & colour		02:00	1A 01	1B 01	1C 01
Sunrise duration & colour		01:00	2A 10	2B 05	2C 28
Daytime duration & colour		10:00	3A 28	3B 28	3C 28
Sunset duration & colour		02:00	4A 15	4B 10	4C 30
Moonlight duration & colour		03:00	5A 02	5B 10	5C 02

## Over Temperature Protection

The smart fans will start to work when the lights are on full, or the temperature of the light is over 38°C (100°F) and will stop when it cools to around 34°C (93°F). If the unit gets too hot, at around 60°C (140°F), the light will shut down and the display will show **Err**

## Blue LED Trim Operation

To control the blue LED trim, point the remote control at the infrared sensor on the light unit at the opposite end from the cable entry.







Press  and  to change the brightness of the blue LED trim up and down.

Press  to turn it off and  to turn it back on again.



If you press  the trim will automatically dim and brighten to create a pulsing effect.

## Troubleshooting

### *The light does not work*

1. Check that it is connected to the power. If not, connect it.
2. Check if the light is in slave mode or off (display showing **Slv** or **OFF**). If so press  to return to run mode.
3. Check if the brightness is set to '0'. Press  or  or  or  or  to adjust the brightness level.
4. Check that the light is not supposed to be off according to your set program. Refer to page 7 to adjust the program.

### *The light is always on*

1. Check if the total photoperiod is over 24 hours in duration. Refer to page 7 to adjust the program.
2. Check the time is set correctly. Press  and  or  to set the time.

### *The screen displays **Err***

1. Check if the top of the unit and fans are blocked or covered. If they are, remove dust/debris to ensure good air flow.
2. Check if the fans are operating. If not then refer to Tropical Marine Centre or your local dealer for replacement fans.

### *The remote control does not work*

1. Check if the light is in slave mode or off (display showing **Slv** or **OFF**). If so press  to return to run mode.
2. Check that the remote control is pointing to the correct infrared sensor on the light unit for the operation you are trying to perform. Refer to page 6.
3. Check the battery. This can easily be replaced with a CR2025 coin cell.

### *The light is flashing*

1. Ensure that the light isn't in storm or demo mode. Press  to return to run mode.



Tropical Marine Centre,  
Solesbridge Lane,  
Chorleywood,  
Hertfordshire, WD3 5SX, UK

**Technical Information Lines**

**Tel: +44 (0) 1923 284151 Fax: +44 (0) 1923 285840**

Open between

9am - 5pm Monday to Thursday/9am - 12pm Friday.

[www.tropicalmarinecentre.co.uk](http://www.tropicalmarinecentre.co.uk) [tmc@tropicalmarinecentre.co.uk](mailto:tmc@tropicalmarinecentre.co.uk)

v.2/2014