

Cannon PRO LED

Technical Specification

Input Voltage: 90-305V 50/60Hz
 Power Consumption: 120W
 Driver: Meanwell HBG Series
 Output Voltage: 48VDC
 Working Temp: -40 to +60°C
 Working Humidity: 20-95% RH
 Dimming input: DALI or 0-10V/PWM/Resistance

Dimensions: 397x160mm
 Weight: 3.17kg
 Snoot length (optional): 64mm

Included

Each CannonPro LED Pendant is pre-assembled and includes:
 1 x High density multichip LED and driver [A]
 1 x Swivel mounting bracket and mounting hardware [B]
 1 x Threaded eye hook with safety harness cable [C]
 1 x Rubber snoot [D]
 2 x Allen keys for bracket adjustment [E]
 3 x Glass optical lenses - 60, 90 & 120 degrees [90 degree pre-installed] [F]

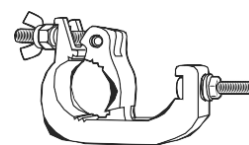
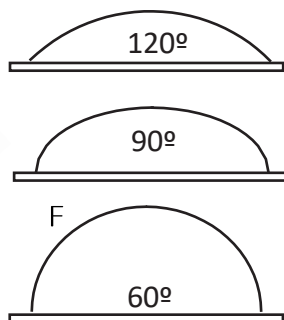
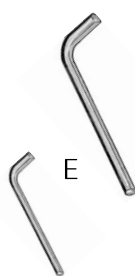
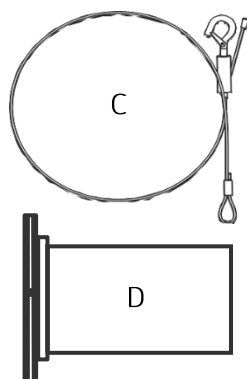
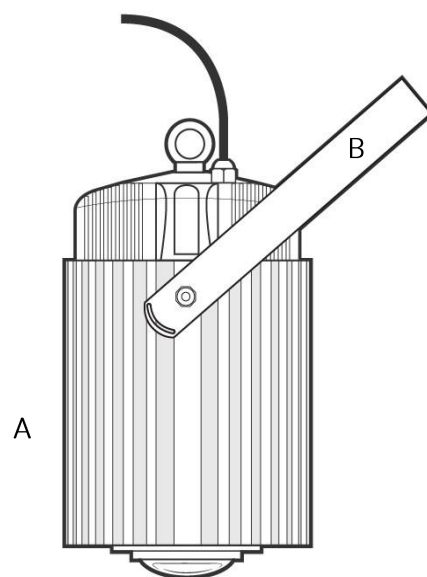

Code: 6897

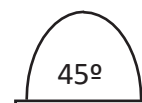

Code: 6895

Optional Accessories [sold separately]

Pipe/strut clamp for 2-4" dia pipe Order code: 6897
 45° lens Order code: 6895

Warnings

- This product must be installed by a licensed electrician.
- The circuit should always be fitted with a ground fault interrupter.
- Never attempt repairs yourself. Return the appliance to an authorised service facility.
- Never operate a fixture that is damaged or malfunctioning. Carefully inspect the fixture before powering.
- Always disconnect from the power supply when carrying out routine maintenance or repairs.
- Do not use the fixture other than for intended use.
- Ensure that the unit is firmly secured before powering up.
- **DO NOT** look directly into the LEDs.
- The fixture is not designed for use inside canopies.

Mounting Instructions





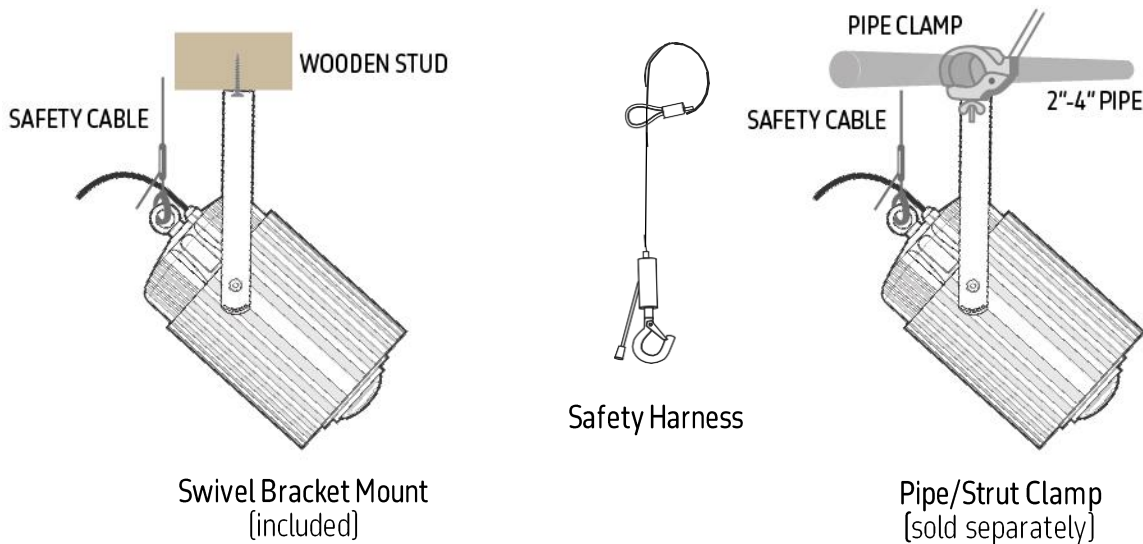

The Cannon fixture must be mounted to a structural mounting point capable of holding a weight of 4kg. You can mount direct to a surface using the Swivel Mounting Bracket, or to a 2" to 4" pipe/strut using the Pipe/Strut Clamp [sold separately]. The supplied Allen keys can be used to adjust the angle of the Swivel Bracket. The safety harness cable should be used at all times. Loop the cable around a firm fixing point and hook to the eyelet on the back of the cannon fixture [as pictured overleaf]. Remove all slack from the safety harness by pushing the cable into the gripper.

Distributed by:



Wiring Instructions

The fixture is supplied with 3 core bare-ended cable and an IP rated quick connect plug and socket to allow ease of maintenance. The bare ended wire can be fitted with a suitable plug for an electrical outlet or hardwired into a suitable junction box using the below guide for reference.

Cable	Output wire of light	AC wire with plug
Phase conductor (Line)	 BROWN	 ANY
Neutral conductor	 BLUE	 ANY
Protective conductor	 GREEN and YELLOW	 GREEN and YELLOW

Once mounted and wired you can power on the light.

DALI fixtures only: The fixture also has a white DC barrel connector fitted. This can be connected to a DALI signal bus and suitable controller to allow timing and dimming down to 5% and off. The Biolumen controllers and cabling accessories are available separately. Please contact Biosystems [details in the footer] for more information.

Please note that if you purchased with a controller, the light may be commissioned to power on at a dim level. This is to prevent light shock to animals in the event of a loss of control signal. The third section of the serial number labelled on the light and box will denote this power-on setting (MIN, MAX, or a number percentage). Once connected to a controller you can then bring it up to maximum output.

The last two digits of the serial number are the unit's allocated DALI short address. You cannot have two or more with the same short address on the same controller as this will cause programming clashes, resulting in erratic behaviour.

Changing the Beam Angle

The glass lens can be changed to suit your needs. Carefully unscrew the lens ring by turning counter clockwise. Once the ring is removed, the existing lens, gasket and reflector can be removed. **DO NOT TOUCH THE LED CHIP.** You can then select the lens required: 120°, 90° or 60°. 45° is available too [sold separately]. Once selected, carefully replace the reflector, gasket, and new lens. Reattach the lens ring – hand tighten only.

The supplied rubber snoot can also be used to further reduce the beam angle and limit glare. This simply pushes over the lens ring.

Warranty

This product is supplied under the terms & conditions of Tropical Marine Centre, along with a limited warranty to cover defects on materials and workmanship for a period of two years from the point of purchase.

Applicable Standards



Distributed by:



www.biosystems-tmc.co.uk

info@biosystems-tmc.co.uk

+44 [0] 1923 284 151